

### Specifications

Nominal Voltage	12V	
Nominal Capacity(10hr)	200AH	
Dimension	Length	522±2mm(20.55inch)
	Width	239±2mm(9.41inch)
	Height	207±2mm(8.15inch)
	Total Height	224±2mm(8.82inch)
Approx Weight	Approx. 58.0kg(+3%)	
Terminal Type	M8	
container Material	ABS(UL-94HB)	
Internal Resistance	Approx.3.0mΩ	
Rated Capacity	204.0AH	(20hr, 1.75V/cell,25°C/77°F)
	200.0AH	(10hr, 1.75V/cell,25°C/77°F)
	190.0AH	(5hr, 1.75V/cell,25°C/77°F)
	168.0AH	(3hr, 1.75V/cell,25°C/77°F)
	118.0AH	(1hr, 1.75V/cell,25°C/77°F)
Max. Discharge Current	2000A(5S)	
Nominal Operating Temp. Range	25±3°C (77±5°F)	
Cycle Use	Charge Current Less Than 0.25CA	
	14.1V~14.7V@25°C(77°F)Temp. Coefficient -30mV/°C	
Floating Use	13.5V~13.8V@25°C(77°F)Temp. Coefficient -20mV/°C	
Capacity affected by Temperature	40°C	103%
	25°C	100%
	0°C	86%
	-15°C	65%
Self-discharge	3 month	Remaining capacity: 91%
	6 month	Remaining capacity:82%
	12month	Remaining capacity:65%

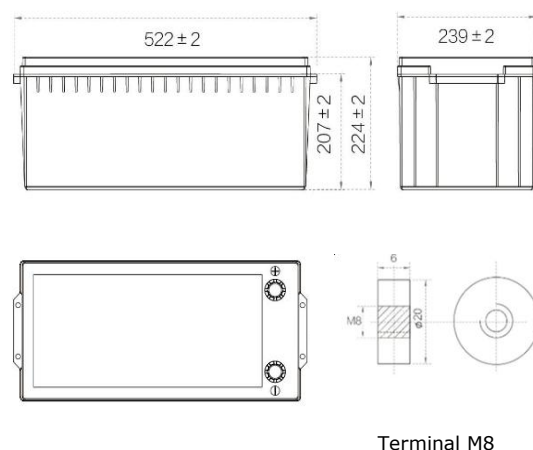

### Dimensions



Terminal M8

Constant Power Discharge at 25°C(77°F)												
F.V/Time	5min	10min	15min	30min	1h	2h	3h	4h	5h	6h	10h	20h
1.80V/cell	786	660	652	402	215	143	105	80.9	69.6	59.7	20.2	20.6
1.75V/cell	870	746	675	413	233	146	107	82.8	70.8	60.8	20.3	20.7
1.70V/cell	958	795	710	420	245	149	109	83.9	71.8	61.8	20.4	21.2
1.67V/cell	975	850	715	432	250	151	111	86.0	72.0	62.5	20.5	21.4
1.60V/cell	999	870	720	445	253	155	112	88.1	72.3	63.0	20.6	21.5

Constant Current Discharge at 25°C(77°F)												
F.V/Time	5min	10min	15min	30min	1h	2h	3h	4h	5h	6h	10h	20h
1.80V/cell	510	430	339	211	119	80.9	58.4	44.7	36.4	29.0	10.0	10.1
1.75V/cell	559	435	348	220	121	82.9	58.9	45.5	38.0	29.3	10.0	10.2
1.70V/cell	580	442	360	223	126	84.9	59.8	46.6	38.7	29.8	10.0	10.2
1.67V/cell	647	469	365	228	131	86.9	60.1	47.1	39.5	30.0	10.1	10.2
1.60V/cell	654	474	370	232	136	88.9	60.7	47.9	40.3	31.2	10.1	10.2

**Discharge Characteristics**

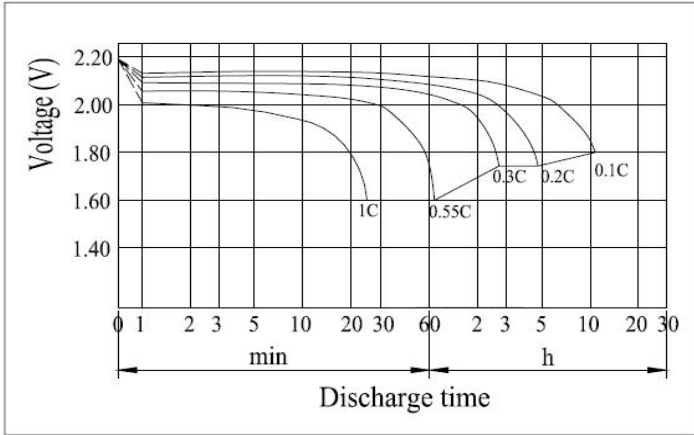

**Float Charging Characteristics**

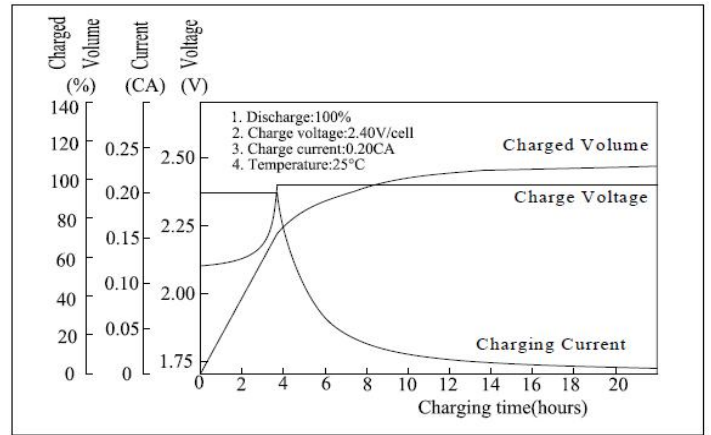

**Floating Life on Temperature**

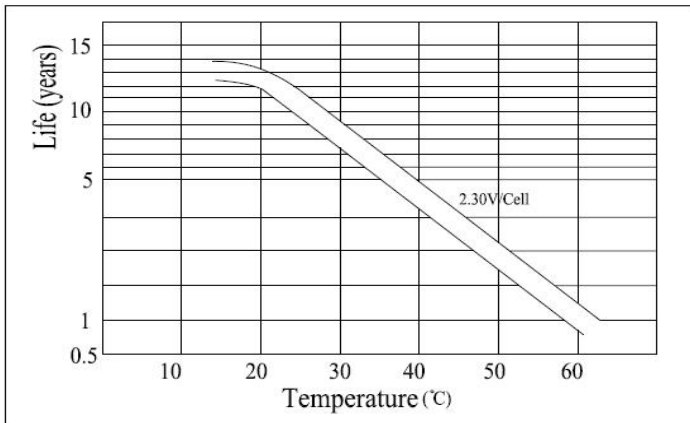

**Self Discharge Characteristics ( 25°C(77°F) )**

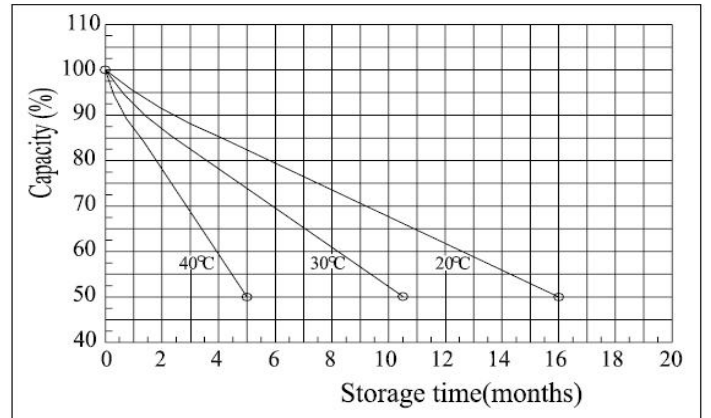

**Temperature Effects in Relation to Battery Capacity**

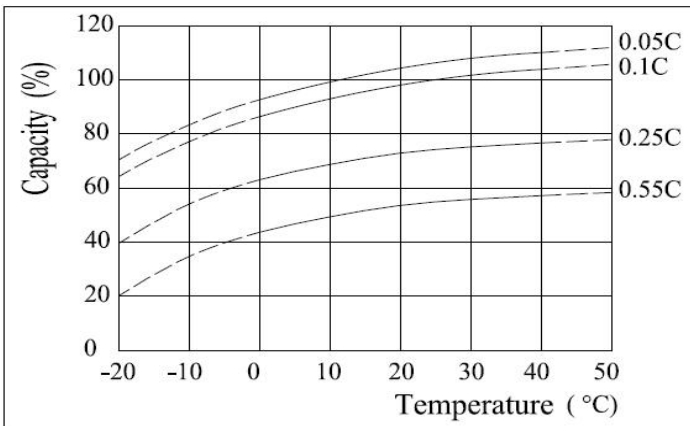

**Cycle Life Relation to Depth of Discharge**

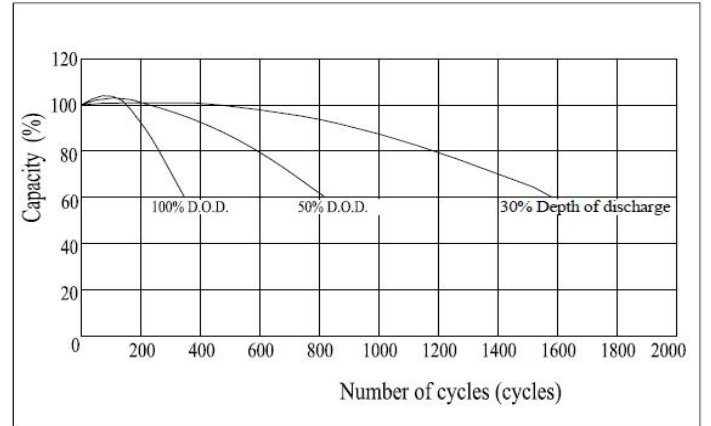

**Quanzhou Singlang Electric Technology Co., Ltd**

[www.xnb-battery.com](http://www.xnb-battery.com)

